

2.4GHz Wireless Outdoor/Indoor Color Camera w/Night Vision & Audio (SM-202T)

Package Contents

- 1 x wireless outdoor/indoor color camera with wall-mount bracket
- 1 x 8V power AC adapter
- Mounting screws

Hardware Basics

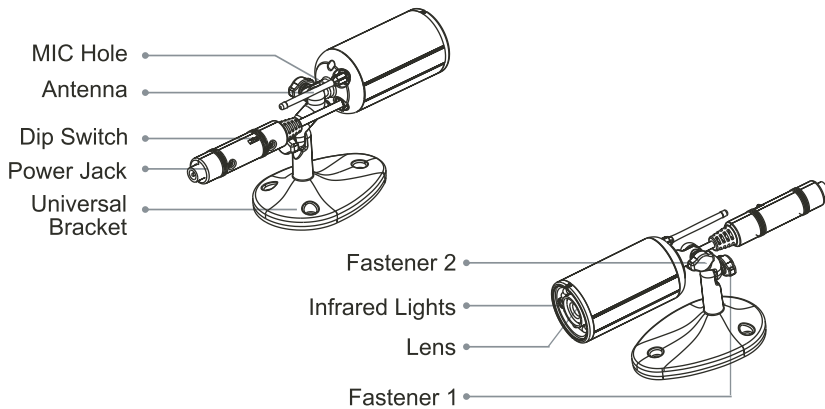

Specifications (SM-202T)	
Image Sensor	1/4-inch CMOS
CMOS Total Pixels	510 X 492 (NTSC)
View Angle	45-50°
Minimum Illumination	3 Lux/F2.0 & 0Lux (IR ON)
Gain Control	Automatic
Frequency	ISM 2400~2483 MHz 4CH (Auto-loop/Manual)
Transmission Power	10mW/CE; 2mW/FCC
Modulation Mode/Bandwidth	FM
Power Supply	18MHzDC +8V 300mA
Consumption Current	200mA (IR ON) & 90mA (IR OFF)
Unobstructed Effective Range	100m (300ft)
Night Vision Range	7m (23ft)
Operation Temperature	-10°C~50°C / 14°F~122°F
Storage Temperature	-20°C~60°C / -4°F~140°F
Operation Humidity	85% RH
Microphone	Built-in
Weatherproof Rating	IP54

Installation Diagram

- 1) Connect the adapter (DC 8V 300mA) to the camera.

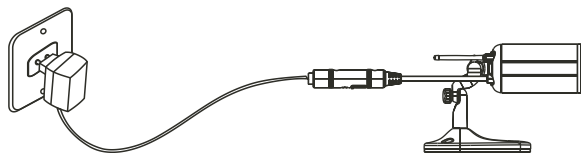

- 2) Set the camera to desired channel.

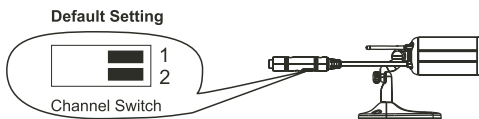

- 3) Connect the antenna to the receiver.

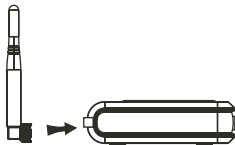

- 4) Connect the receiver to a monitor/TV with AV cable (yellow for video and red audio). Turn on the monitor/TV and select AV mode.

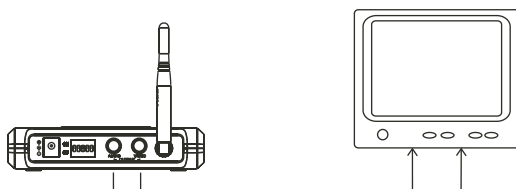

- 5) Connect the power jack of adapter (DC 7.5V 300mA) to receiver. Press the **Power ON/OFF "⏻"** button and the channel indicator lights up green.

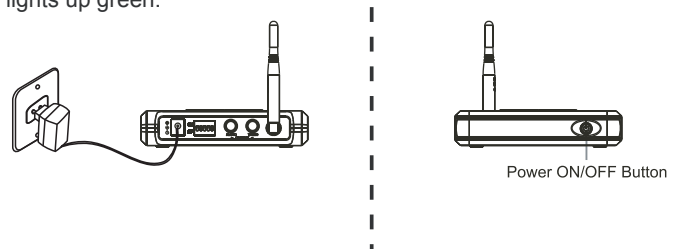

- 6) Press the Channel Select Button "CH" on the receiver until the channel indicator matches to the channel on the corresponding camera, and monitor/TV will display pictures.

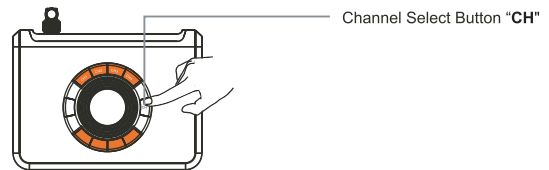

- 7) Adjust the brightness, contrast and color of the monitor/TV for the perfect effect.

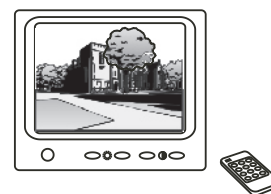

Notice:

2.4GHz wireless camera works at ISM band. It may cause interferences with other wireless equipment that operates with the same band. Please turn off one of the equipment to eliminate the interference.

Product Assurance

2.4GHz wireless camera will emit electromagnetic wave, just like other wireless products. But the output power of the product is less than other wireless products such as mobile phones. The 2.4GHz wireless camera meets wireless frequency security standards and recommend indexes while working. These standards and indexes are certificated by academic organization and represent the cogitative research of the scientific workers who continuously explore and annotate the involved fields. So we believe that our products are safe for customers.

Operating Restrictions

DO NOT use this product to violate one's privacy. Monitoring one's activities without consent is illegal and this product is not designed and manufactured for these purposes.

DO NOT put this product near any medical equipment. Radio waves might potentially cause breakdown of electrical medical equipment. This product should be placed at least 1 feet away from any heart pacemaker. Radio waves might potentially influence heart pacemaker and lead to respiratory disturbance.

DO NOT use this product for any illegal activities. SecurityMan shall not be responsible for any consequences of illegal conducts by users

Conditions

Please read the following messages to make sure whether your working environment is suitable.

- Ensure there is enough space around the receiver for ventilation.
- The temperature should be kept between -20°C and 50°C (-4°F-122°F). The relative humidity should remain from 20% to 80%.
- Avoid putting the product in places where occur might change rapidly in temperature or humidity
- Keep it dry, dustless and avoid exposure in it directly in sunlight
- Keep product away from heat sources such as electric heater
- Do not use the camera near aggressive chemicals
- Do not place product near any magnetic objects

Maintenance

It might influence the normal operation of the product if used at the fringe range of normal temperature. Please turn off the power when not in use. Do not disassemble the product. Do not shake or stricken the product. Do not use this camera near water - for example, near a bath tub, wash bowl, kitchen sink or laundry tub, in a wet basement or near a swimming pool. Please obey the local government's environment protection policy.

Warning:

- In order to avoid inflammation or electric shock, this machine should be kept away from exposure to rain or moist, and it shall not be put in or near bathrooms, wasjng pools, washhouses, moist basements, or swimming pools.
- In use of sockets set on walls or extension wires, attention should be paid not to exceed their load capabilities to avoid inflammation or electrical shock.
- Casings are not allowed to open, otherwise the internal precision parts may get damaged, or personal injury caused.
- Switch off the power supply in thunder and lightning or when not in use for long periods of time.
- Do not attempt to service the product yourself as opening or removing covers may expose you to dangerous voltage or other hazards. Refer all servicing to qualified service personnel.

Copyright Notice

This manual is furnished under license and may be used or copied only in accordance with the terms of such license. Except as permitted by such license, no part of this publication may be reproduced, stored in a retrieval system, or transmitted, in any form or any means, electronic, mechanical, recording, or otherwise, including translation to another language or format, without the prior written permission of SecurityMan.

The content of this manual is furnished for informational use only, is subject to change without notice, and should not be construed as a commitment by SecurityMan. SecurityMan assumes no responsibility or liability for any errors or inaccuracies that may appear in this book. All other product names, trademarks and registered trademarks in this document are the properties of their respective holders.

FCC Information

Notes on FCC's "Consistent Statement of Information" This product meet the requirements specified in Part 15 of FCC Regulation. Operation rests with the following two conditions:

- (1) The equipment should not cause any harmful interference.
- (2) The equipment must receive and process any interference, including any possible interference caused by operation mistakes.

After testing the product, we confirm that the camera complies with the provision for class C digital equipment in the 15th part in FCC regulations; and the receiver complies with the limitations for class B digital equipment in Part 15 of FCC regulation. The product generates, applies and emits radio waves. It might cause harmful interferences to wireless communication if not be installed and used following the description of the manual.

The product may cause interference in residential area, and the customer should take remedies to eliminate the interference on their own costs.

If the product causes any harmful interference to wireless equipment or disturbs the receiving of TV signals (it can be identified by turning on and off the product), you can solve the trouble by following methods:

- Readjust the product or put it in another place.
- Extend the distance between the equipment interfered and the product.
- Refer to dealers or experienced radio electrician for help

Warranty

SecurityMan warrants that this product will be free from defects in materials and workmanship for period of time specified on the product packaging. This limited warranty shall commence from the date of purchase. SecurityMan products warranty is not transferable and is limited to the original purchaser. If the product is found to be defective then, as your sole remedy and as the manufacturer's only obligation, SecurityMan will repair or replace the product. This warranty shall not apply to products that have been subject to abuse, misuse, abnormal electrical or environmental conditions, normal wear and tear or any condition other than what can be considered normal use.

Limitation of liability

The liability of SecurityMan arising from this warranty and sale shall be limited to a refund of the purchase price. In no event shall SecurityMan be liable for costs of procurement of substitute products or services, or for any lost profits, or for any consequential, incidental, direct or indirect damages, however caused and on any theory of liability, arising from this warranty and sale. The sell limitations shall apply not with standing any failure of essential purpose of any limited remedy.

For Customer Service: 888-977-3777

SecurityMan

4601 E. Airport Drive, Ontario, CA 91761, USA

Tel: (888) 977-3777 or (909) 230-6668

Fax: (909) 230-6889

email: info@securitymaninc.com

website: <http://www.securitymaninc.com>

Copyright 2007 by SecurityMan v1.1